

# **TR20-160**

## **Lidar transient recorder**

# **Manual**

December 7, 2012

## Contents

<b>1</b>	<b>Product description</b>	<b>3</b>
<b>2</b>	<b>Principle of operation</b>	<b>4</b>
<b>3</b>	<b>Preparation for use</b>	<b>5</b>
3.1	Installation of I/O card (only for systems with NI-DIO interface) . . . . .	5
3.2	Software driver installation . . . . .	5
3.3	Transient recorder hardware address . . . . .	5
3.4	Memory Length . . . . .	6
3.5	Trigger . . . . .	7
3.5.1	Option: Trigger-Splitter . . . . .	7
3.5.2	Option: Laser-Trigger . . . . .	8
3.5.3	Debugging trigger problems . . . . .	8
3.6	Signal . . . . .	8
3.7	Parameter settings . . . . .	8
<b>4</b>	<b>Operation</b>	<b>9</b>
4.1	Signal acquisition . . . . .	9
4.2	Bin shift . . . . .	11
4.3	Analog background . . . . .	11
<b>5</b>	<b>Maintenance</b>	<b>11</b>
5.1	Safety . . . . .	11
5.2	Cooling . . . . .	12
5.3	Calibration . . . . .	12
<b>6</b>	<b>Trouble shooting</b>	<b>14</b>
<b>7</b>	<b>Specifications</b>	<b>15</b>

## 1 Product description

The licel transient recorder is a data acquisition system for fast repetitive photomultiplier current signals, which are transformed at the internal 50 Ohm termination to a voltage between 0... -500 mV. The signal is recorded simultaneously by a 12Bit, 20MHz analog to digital converter and a discriminator which detects voltage pulses above a selected threshold in the range 0... -100 mV. By using this combination of analog and photon counting detection the licel transient recorder is especially suited to record high dynamic range signals in lidar applications.

Each TR 20-160 contains 2 preamplifiers optimized for high linearity for analog detection and for maximum speed and gain for photon counting, a 12-Bit A/D converter with fast memory for 16k of single shot data, a discriminator with variable threshold, counter and multi channel scaler as well as a hardware adder to perform summation of up to 4094 shots on board. Data transfer and selection of input ranges and discriminator threshold is realized by a parallel data bus, connected to a PC I/O-card or Ethernet controller. Up to 16 transient recorders can be controlled and readout using the same bus.

## 2 Principle of operation

An acquisition system using the TR20-160 can be configured for up to 16 simultaneous detection channels. Such a system is configured by using a HF cassette mounted transient recorder module for each channel, a rack comprising power supplies and interface ports and a PC or Apple computer which is equipped with a Ethernet connection or a National Instruments digital I/O card (DIO-32HS). Each channel can be configured and controlled separately by the host computer.

The basic setup used to amplify and record signals in the licel transient recorder is shown in the schematic below: For analog detection the signal is amplified, according to the input range selected, and signals below a frequency of 10MHz are passing the anti-alias filter to be digitized by a 12Bit 20MHz analog to digital converter. Each signal is written to a fast memory which is readout after each shot and added to the summed signal in a RAM. Depending on the trigger input on Trigger A or Trigger B, the signal is added to RAM A or B, which allows acquisitions of two repetitive channels if these signals can be measured sequentially.

At the same time the signal part in the high frequency domain above 10 MHz is amplified and a 250 MHz fast discriminator detects single photon events above the selected threshold voltage. Two different settings (threshold low and threshold high mode) of the preamplifier can be controlled by software together with 64 different discriminator levels. Again the signal is written to a fast memory and added to the summation RAM after each acquisition cycle.

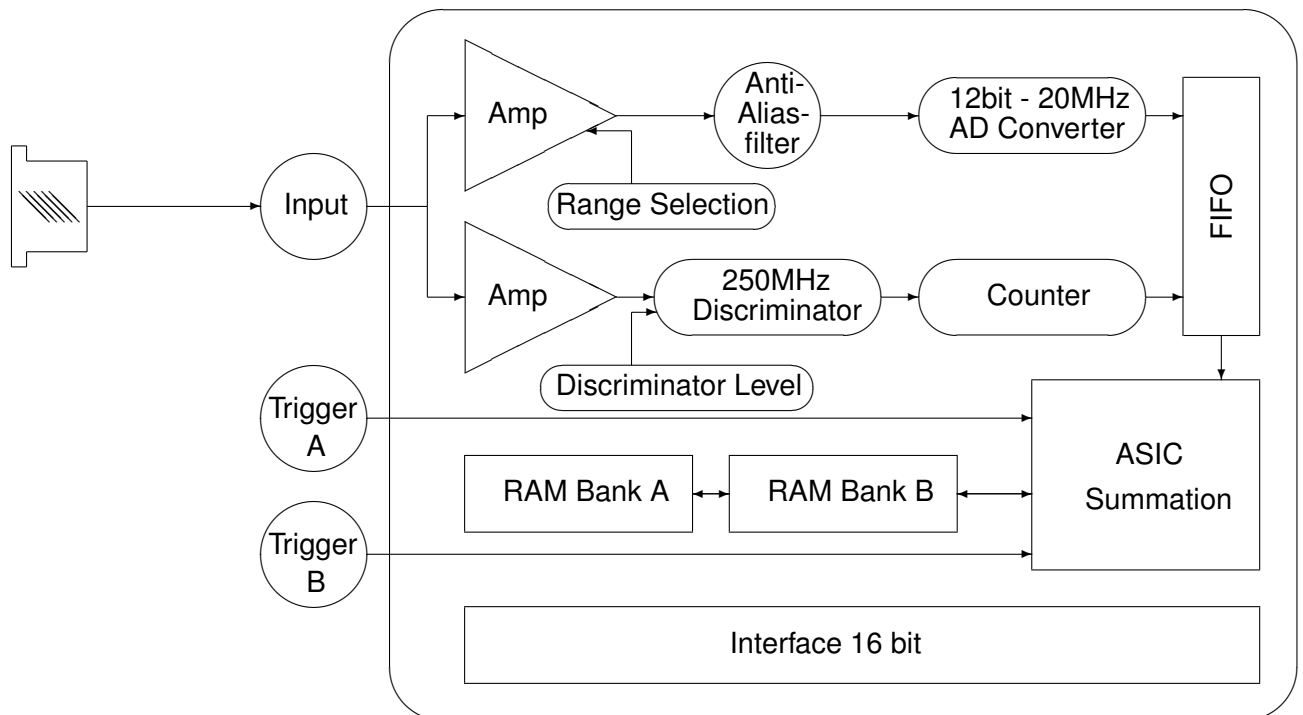

*Schematic setup*

## **3 Preparation for use**

### **3.1 Installation of I/O card (only for systems with NI-DIO interface)**

Your computer should be turned off and the power cable removed before you open the housing and plug a NI DIO-32HS into a slot of your PC.

For further information on the NI card please refer to the National Instruments documentation.

### **3.2 Software driver installation**

The software package supplied with your licel transient recorder contains LabVIEW modules and alternatively C-sources to be integrated in your own acquisition programs and a few ready to use LabVIEW acquisition modules to perform multichannel measurements.

The module "track.vi" can be used to check your signal at different input ranges and discriminator thresholds. The output is displayed on screen only.

The module "live display.vi" can be used to have an oscilloscope like display for a single transient recorder.

The module "acquis.vi" can be used to perform a set of consecutive measurements with a predefined number of shots where the summed signals are written to disk.

### **3.3 Transient recorder hardware address**

Each transient recorder is identified by its hardware address, which can be set using the DIL-4 switch on the board, which is located close to the 50-pin interface connector. In multichannel systems the transient recorders are factory set to consecutive addresses, starting at 0 for the leftmost channel in the rack.

The addresses range from 0 to 15. Each address should be unique in the system. In order to change the transient recorder address later you need to unmount the transient recorder first. Once the right side panel is open on the right side of the board a red switch should be visible. The switch encodes binary the address

The ON position corresponds to a binary 1.

before Oct. 2009      since Oct. 2009

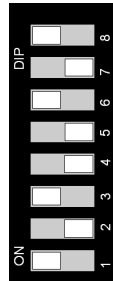
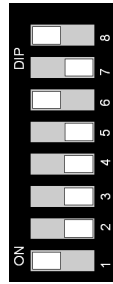
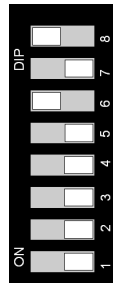
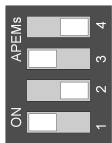
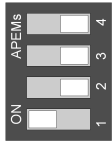
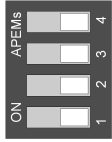

All switches are off, the resulting address is 0. This is the factory default for the left most transient recorder in a Rack-6 or the topmost in a Rack-2.

The lowest switch is on ( $2^0$ ), the resulting address is 1

The lowest switch is on ( $2^0$ ), the switch corresponding to four is also on ( $2^2$ ), the resulting address is 5

Connect the rear connector of the transient housing to the Ethernet or to the I/O-card, using the interface cable supplied and turn on the power of transient recorder and computer. The hardware address of each channel can now be verified by watching the Host I/O indicator, when different channel numbers are selected in the acquisition software and any command is sent.

### 3.4 Memory Length

Starting from October 2009 TR units will have 64k deep memory, which can be configured by the user for shorter memory depths.

Memory Depth	6	7	8
512	OFF	OFF	OFF
1k	ON	OFF	OFF
2k	OFF	ON	OFF
4k	ON	ON	OFF
8k	OFF	OFF	ON
16k	ON	OFF	ON
32k	OFF	ON	ON
64k	ON	ON	ON

The address selection above shows a 16k memory configuration

**Setting the switch 5 to the ON position will limit the memory length to 322 bins. Setting it to OFF will activate the behavior shown above**

### 3.5 Trigger

Connect your trigger source to the Trigger A or Trigger B input. Make sure, that your trigger source is able to drive the required 50 Ohm input load. Depending on your input the signal acquired will be summed and stored to memory A or B. This can be used to acquire two alternating signals.

Any trigger pulse which occurs during the acquisition and summation will be ignored as well as trigger pulses after more than 4094 acquisitions on either trigger A or B.

A valid trigger pulse is indicated by the "Run" LED.

Typical trigger sources are:

- The laser Q-switch out pulse,
- the a photodiode picking up a fraction of the outgoing beam,
- a function generator
- a timing pulse generator.

**Laser Q-switch out** The signal coincides with the actual laser shot. Typical lasers might have difficulties to drive the required 50  $\Omega$  input impedance and produce a pulse that exceeds 2.5V for more than 150ns. In this case the pulse needs amplification. A driving circuit scheme can be found at <http://www.licel.com/PulseShaperTrigger.pdf>.

**Photodiode** Licel supplies a solution for this as described under Option: Laser-Trigger which will drive the transient recorder. A custom made solution should deliver 2.5V @ 50  $\Omega$  for more than 150ns.

**Function generator** This is very convenient source for lab testing, connect the sync out of the function generator to the transient recorder input as described below.

**Timing generator** One should use this option if a pretrigger is required or a chopper wheel is used. Licel supplies a small module that fulfills the typical LIDAR system requirements.

#### 3.5.1 Option: Trigger-Splitter

In multichannel systems a trigger splitter is integrated into the power supply in the 6-channel rack.

You can select between two setups to trigger all transient recorders in a rack 6 simultaneously or individual triggering of each transient recorder.

**a) Common trigger using the trigger splitter:** The trigger splitter is integrated into the power supply in the 6-channel rack. Connect your electrical trigger source to the "Trigger in" input. This trigger source will trigger all transient recorders in the rack 6 together and acquire signals into memory A. An additional connection to the BNC trigger inputs of each transient recorder is NOT required.

**b) Individual trigger for each transient recorder:** Connect your trigger source to the Trigger A or Trigger B input of each transient recorder. Make sure, that your trigger source is able to drive the required 50 Ohm input load. Depending on your input the signal acquired will be summed and stored to memory A or B. This can be used to acquire two alternating signals or to store two consecutive sets of up to 4094 acquisitions.

### 3.5.2 Option: Laser-Trigger

In high repetition rate systems using a passive Q-switched laser, the laser pulse as detected by a photodiode can be used to trigger the acquisition. Connect the photodiode to the input "Photodiode" (Cathode connected to shield), Direct a small fraction of the laser light (use any back-reflection) onto the photodiode while observing the "Monitor" output on an oscilloscope. Increase the threshold with the potentiometer. At very low discriminator settings the noise signal will trigger the acquisition, at a very high discriminator setting the trigger will stop. Find both extreme values and adjust the threshold to a medium level.

The transient recorders will be triggered via the 50 pin bus cable inside the rack. Do not use the Trigger A/B inputs of the transient recorders.

### 3.5.3 Debugging trigger problems

Please connect a BNC T to the oscilloscope and select a high impedant input at the oscilloscope. Connect then one BNC cable from the trigger source to one side of the BNC T and another cable from the BNC-T to the transient recorder.

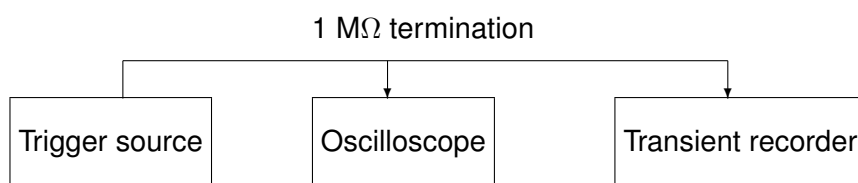

Record then the shape of the trigger pulse at the oscilloscope, it should be longer than 150 ns and more than 2.5V. The rise time should be less than 20 nsec. If it does not match you might need to amplify the signal or prolong the pulse.

## 3.6 Signal

Connect your photomultiplier anode output to the signal input of the selected transient recorder. The connecting cable from the signal source to the signal input should be as short as possible. The builtin preamplifier are designed for direct input of a photomultiplier signal, where the internal 50 Ohm resistor of the preamplifier is used as load resistor for your photomultiplier. The signal input is diode clamped for overvoltage detection but signal levels above -15 V can lead to damage of the protection diodes and should be avoided.

## 3.7 Parameter settings

To select the analog input range for your measurement first observe the signal in single shot acquisitions. The peak signal amplitude should never exceed the selected input range, since this would result in an underestimation of the averaged signal. The built in overrange detection can be used to control the peak signal during an acquisition. If any single signal exceeds the input range selected, the affected memory bin will be marked as clipped. By evaluation of this information after the measurement, the affected memory bins can be identified.

The discriminator setting should be selected based on the pulse height distribution. Too low discriminator levels (below 3) make the system vulnerable to RF noise.

The Threshold Range can be set to high if large photons will cause an after pulsing that would otherwise overflow the internal preamplifier.



## 4 Operation

### 4.1 Signal acquisition

Using the LabVIEW module "aquis.vi" you can perform automatic data acquisitions using multiple signal sources and transient recorders. Each acquisition cycle is performed by the following steps:

1. The discriminator is set to the selected discriminator threshold, the preamplifier is set to the desired input range.
2. The internal summation memory and acquisition cycle counter is cleared. This step is indicated by the "Run" LED of each transient recorder.
3. The trigger is armed. Start of your measurement.
4. Deactivation of the trigger input, end of acquisition. This step can be done by the user or is performed automatically after 4094 acquisitions.
5. Readout of the summed data for analog and photon counting signals from memory 1 and/or 2. Readout of the counted number of shots.

During the measurement valid trigger pulses are displayed by the LED "Run" of each module. A signal above the selected analog input range, leading to clipping of the signal is indicated by the LED "Clip". Each communication between transient recorder and host computer is indicated by the LED "I/O".

## Input and Controls

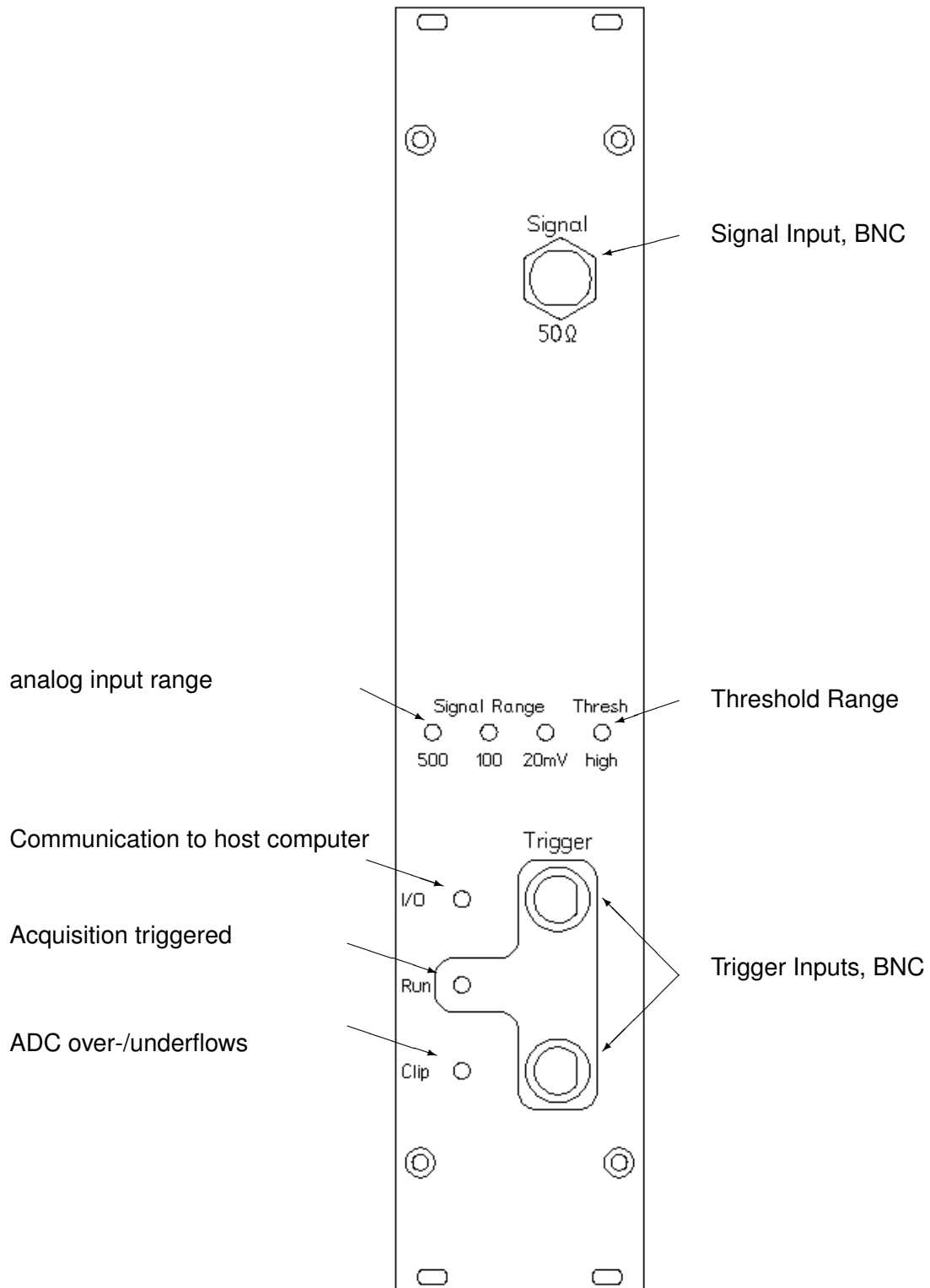

## 4.2 Bin shift

The analog and the photon counting data has a fixed shift between them. This is a result of two factors:

- Analog Bandwidth, the preamplifier contains an antialias filter which has a bandpass of half the sampling frequency this delays the analog signal with respect to the photon counting by 2 bins
- ADC pipelining, modern ADCs sample the voltage in a multiple step process so that the sample result will be available several clock cycles later after the actual sampling took place.

You can verify the bin shift for your TR by measuring under dark conditions the dark counts from a PMT with applied HV. When you take single shot measurements with `Track.vi` and switch between the analog and photon counting data set you will see that the needles in photon counting also correspond to needles in the analog but they are at slightly different positions. This shift is fixed and does not change with time for a given TR.

## 4.3 Analog background

The analog background is elevated intentionally, there are several reasons

a) We use a unipolar input range of the ADC instead of a bipolar, where the signal could go from -500mV to +500mV. The reason to use the unipolar is to give you the best possible ADC resolution, as positive signals will not come out from a PMT, it is negative going usually. There are PMT's out that make this different but they are seldom and use typically a preamp inside the housing which will not fit to the TR without a modification of the preamp.

b) The signal however can not start from 0 directly because every single photon while going negative typically also shows a slight overshoot into the positive direction. You can observe this using the `Track.vi`. Connect a dark PMT with HV to the transient recorder and look for the photon counting data, once you see a single count switch the display to the analog mode. You will see a spike and the little undershoot below the baseline. The signal is displayed inverted so negative going photons will be go in the positive direction.

c) As those overshoots are part of the signal they need to take part in the average computation. A too low offset will clip them and then your average is compromised. To make sure that this will not happen we do two things:

- we elevate the analog background level
- we provide the clipping information both on the front panel and in the data that is retrieved from the transient recorder.

d) The clipping lamp goes bright when the ADC sees a 0 or a full scale  $0xFFFF = 4095$  value. At both conditions we are not sure that the average is not compromised by clipping. As soon as the lamp goes on we will also mark internally the bin as clipped. (See <http://www.licel.com/programmingManual.pdf> page 19 Memory organization.)

This clipping information is used in the `Track.vi` and `Live display.vi` when you switch the Set Overflow Values to 0 and it will when overflows occur mark "innocent" looking averages with down to zero going needles. It is not used in the `Acquis.vi` as it would reduce signal quality and make a lot of algorithms grinding to a halt.

# 5 Maintenance

## 5.1 Safety

Before opening the rack the power supply should be turned off and the power cable removed for your personal safety. When opening the power supply cassette be aware of capacitors that can be still charged and lead to high currents although the unit is not connected to AC power.

Each transient recorder can be removed after opening the 4 screws at the front panel.

To remove the power supply unit, 2 additional screws below the side cover of the 19" rack have to be removed.

## 5.2 Cooling

The power supply of the transient recorders is using linear voltage controllers and therefore should be air cooled during operation. The air inlet is located at the lower front side of the housing the outlet is at the top rear side. Make sure that the ventilation system is not obstructed. Three LED's are indicating the supply voltage of 5 and +15V. If any of these LED's is off, check the power supply fuses. They are located at the rear side of the housing. Additional fuses are located on the power supply boards inside the cassette. AC fuses are located in the power cable terminal at the rear side of the housing.

## 5.3 Calibration

If the clip lamp at the transient recorder flashes during acquisitions you might need to check for the over/-underflow. This is done with the Track or Live Display.vi where the "Set Overflow to 0" switch is activated. If you see then needles that go down to 0 for small signals, then the offset for the input might be to low and changing the calibration would help to solve this. If you are in doubt send a screen shot of the Track.vi with the signal to Licel to discuss if a recalibration is required.

The offset and gain of each channel can be recalibrated by using the following procedure:

1. Turn on the system for at least 20 minutes to reach stable temperature conditions.
2. Unscrew the 4 screws at the front plate of the transient recorder to be calibrated and pull out the cassette about 15 cm.
3. Use a plastic shielded screwdriver to turn the trimmers which can now be accessed from the right hand side. Connect a trigger source and start with the offset in the 500 mV range. Without input signal the offset should be 5 mV.
4. Apply a -480 mV DC signal and set the gain until this voltage readout correct.
5. Calibrate again alternating the offset and gain until both settings are correct. The repetitive procedure is necessary since the gain setting affects also the offset level.
6. Calibrate the 100 mV and 20 mV range using the same procedure as above.

An offset level above your single shot noise amplitude is necessary to prevent clipping by underflows of the A/D converter. Like overrange signals this would lead to wrong results in the summed signal of an acquisition.

BNC Input

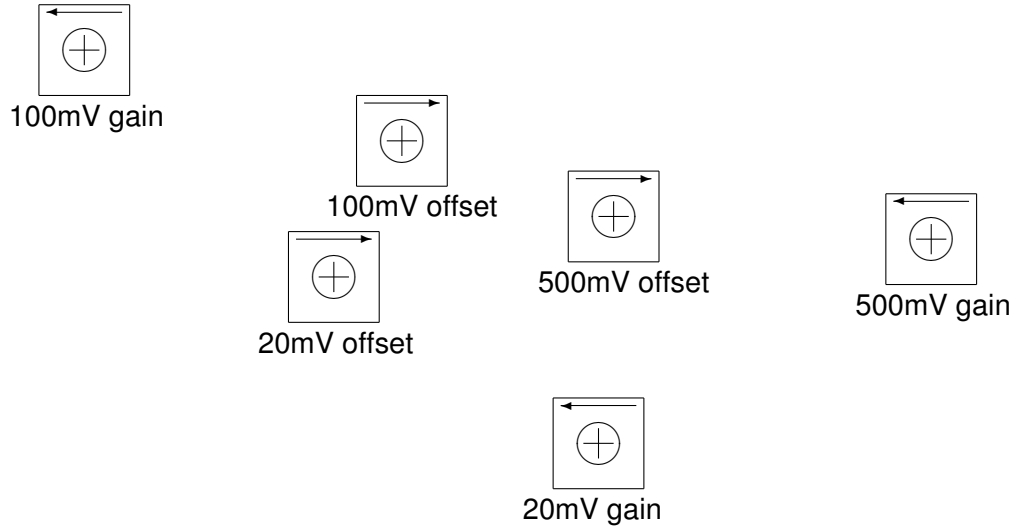

The arrows show the direction to increase the offset or gain

## 6 Trouble shooting

**Failure of a power supply:** Three LED's in the front of the power supply unit show the operation for +5V, -5V and +15V supply. In case of failure of one supply check the fuses in the back of the power supply. Check the fuses inside the power supply cassette.

**No data transfer:** The LabVIEW error message "Error -10800 occurred at ..." means that no handshake signal from the transient recorder was received with the hardware address selected. Check the hardware address selected in your configuration first. Check the interface cable for correct connection. The host I/O LED of each transient recorder indicates a handshake signal between I/O card and transient recorder.

**Analog and photon counting signal is 0** Check whether memory 1 is readout when you use Trigger input A, or memory 2 is readout when you use trigger input B. Do the "Run" LED and the number of shots readout indicate valid trigger pulses? Check the slope of your trigger source (trigger on rising edge).

## 7 Specifications

### Analog acquisition:

Signal input range:	0... -20 mV, 0... -100 mV, 0... -500 mV
A/D Resolution:	12Bit
Sampling rate:	20 MSamples/second.
Lidar spatial resolution:	7.5 m.
Bandwidth:	DC-10 MHz.
A/D differential nonlinearity:	typ. 0.65 LSB, max. 1.25 LSB @25° C.
A/D integral nonlinearity:	typ. 1 LSB @25° C.
Spurious free dynamic range:	74 dB
S/N single shot:	66 dB @ 100 mV input range (50 $\mu$ V).
Memory depth:	322 bins.
Typical binshift:	7 bins
Summation memory:	2 channels 24 Bit, 4094 acquisitions.
Protection:	Diode clamped.
Input impedance:	50 $\Omega$
Coupling:	DC

### Photon Counting Acquisition:

Max. count rate:	250 MHz.
Signal input range:	0... -25 mV/0...-100 mV (thresh low/high)
Input impedance:	50 $\Omega$
Protection:	Diode clamped.
Discriminator:	64 levels for each input range, software controlled.
Lidar spatial resolution:	7.5 m.
Memory depth:	322 bins.
Summation memory:	2 channels 16 Bit, 4094 acquisitions.
Input impedance:	50 $\Omega$
Bandwidth:	0 - 300 MHz no dead time or overlap between bins

### Trigger:

	2 Trigger inputs to acquire signals in 2 separate summation memories.
Impedance:	50 $\Omega$
Threshold:	2.5 V
Slope:	positive
Trigger delay and jitter:	50 $\pm$ 25 ns.
Repetition Rate:	300 Hz
Power Consumption:	
+5.1V	0.6A
-5V	0.5A